

## Comparative Analysis of HRES Having STATCOM and CHSA

Kundan Kumar Singh<sup>1</sup>, Vivek Yadav<sup>2</sup>

<sup>1</sup>Kundan Kumar Singh, Mtech Scholar, Department of Electrical and Electronics Engineering, RKDF Institute of Science And Technology, Bhopal

<sup>2</sup>Vivek Yadav, Assistant Professor, Department of Electrical and Electronics Engineering, RKDF Institute of Science And Technology, Bhopal  
[kundan8269203520@gmail.com](mailto:kundan8269203520@gmail.com), [vivekyadav.1185@gmail.com](mailto:vivekyadav.1185@gmail.com)

\* Corresponding Author: Kundan Kumar Singh

**Abstract:** In a world where energy resources are diminishing, the usage of renewable energy sources is critical to meeting rising needs. The best option for combating the use of finite resources is to generate electricity using solar and wind energy resources. The best feature is that it really is a non-polluting source of energy. Here we are comparing results of hybrid renewable energy resources in two cases firstly HRES having STATCOM and secondly HRES having constrained Hawk search algorithm regulated compensator.

**Keywords:** HRES, STATCOM, Hawk search algorithm, microgrids, WECS

### I. Introduction

The incorporation of many kinds of energy initiation equipment, including electrical power power stations, electrical storage mechanisms, and renewable energies, is described as a hybrid energy system. Grid linked, isolated from the grid, and special-purpose hybrid energy systems can all be used. Current research in the field of hybrid energy system workflow have taken into account the uncertainty and risk linked with renewable energy manufacturing and load requirements. The long extension alternative for microgrid (MG) processes is the hybrid energy system (HES), also known as hybrid power. In broad sense, inertial and non-inertial renewable technologies (ESs) as well as power conversion equipment make up MG. In order to make sure a sustainable, ongoing, effective, and top notch power source to the load demand, functioning MG relying on HES in real - time basis is a complicated process involving optimum solution and adaptive control. Long-term energy performance and relatively brief power control strategies are also recommended for MG implementations, in which hourly predictions of Decentralized Energy Supplies, governance of control loops, and provisioning of levels of energy additional capacity, among other things, must be regarded.

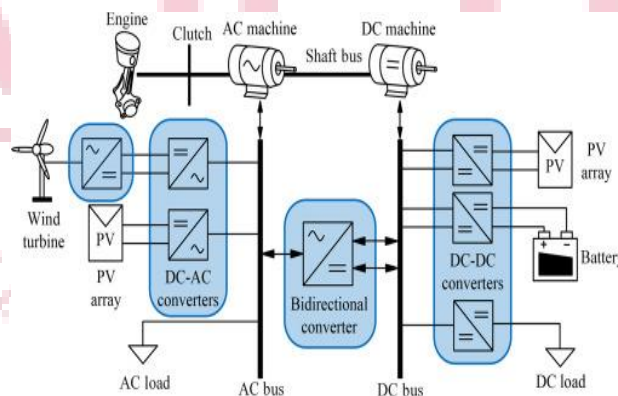

Figure 1: Hybrid Renewable Energy System

In stand-alone implementations, hybrid energy systems are a very hopeful and long-term alternative for power creation. Due to complex methodology engaged in the building up and enhancement of these processes, research & innovation in such innovative technologies will almost definitely result in lower system costs. Optimal resource distribution, relying on load requirement and renewable resource predicting, has the opportunity to profoundly lower the system's overall operating costs. Numerous different relevant factors, including emission control reductions or system stability maximization, are becoming extremely relevant in addition to standard least cost considerations. Innovative models that authentically characterize the systems aid in the enhancement of hybrid energy system setup, layout, and procedure

### II. Literature review

(El-Raouf et al., 2019) [1] Maximum power point tracking (MPPT) of a Photovoltaic-wind hybrid system supposed to feed a new group in Egypt-New El-Farafra Oasis as a prime example is suggested in this paper. The framework involves a photovoltaic system, a wind turbine including a synchronized generating with permanent magnets, and a fuel cell with an energy storage system (ESS). MPPT was implemented to PV, wind, and fuel cells independently via three DC-DC buck - boost converter using the Cuckoo search (CS) AI technique. Following the MPPT method suggested to a common

DC bus, these adapters are often employed to boost and create a unified the voltage output of the three main sources. A DC/AC inverter is used to connect the hybrid power system to the suggested community's AC loads. The three converters and inverter are governed by a Particle Swarm Optimization-tuned Control scheme (PSO). The findings demonstrate the Cuckoo Search regulate technology's capabilities to attain MPPT for every generating station. The PI controller of both adapters and power converter styling, on the other side, is mentioned. The suggested hybrid system was successful in feeding the fresh community's AC loads at Maximum power point.

(Ghosh et al., 2016) [2] Standalone windmills can only reach heights of 80 to 100 metres. However, kites can operate at a least altitude of 300m - 1000m, which has the potential to collect so much power than stand-alone generators that produce electro - mechanical torque using tether tension. Aerial positional awareness and restricted movement of aerodynamically self-sustaining trying to fly kites sets up as its own senseless wind generation device. However, the wind in any location is subject to change depending on the climatic condition, which really is extremely uncertain. Because of the uncertainty of wind, a stable power generation cannot be achieved, necessitating the use of a power storage system is to maintain a stable power supply. As a result, SPV systems are combined on the textured kite wrapper to minimize reliance on the wind. This adds another source of power to the system, providing an efficient and inventive. The addition of SPV modules to the kite envelope represents a seamless power source. This kite can generate both solar and wind energy as during suction phase. It will not create any renewable power during the passive phase, and no constant power shipment will be achieved. As a result, flywheel energy storage is incorporated into the system that connects the winch to the dual-purpose synchronous generators. In the case of limited wind, this impeller provides constant mechanical torque to the machine's rotor, resulting in a constant power supply. This stable power supply can also be fed into the AC power grid. This system's ability to generate both solar and wind power qualifies it as a sustainable hybrid power generation system that can also be used to provide power to remote areas.

(Bharanikumar et al., 2008) [3] Maximum Power Point Control for a permanent-magnet generator operated by a varying speed of wind turbine is presented in this study. The duty cycle of the power supply is modified, and the effectiveness of the Wind Energy Conversion System (WECS) is improved, by operating the windy turbine connected to a generator such that the angular velocity varies with the winds. For each maximum velocity, the Maximum Power Point Tracking (MPPT) approach is utilized to extract maximum power. To catch the most wind power, the permanent-magnet generator's spinning speed must be modified in real time. The wind turbine, permanent magnet generator (PMG), three-phase rectifier, boosting compressor, converter, and load are all part of the system. The duty cycle of the chopper is the control variable. To deliver the best results, PMG is designed to run at a flexible pace. The windfarm, PMG, and power conversion models make up the complete WECS model. For modeling, MATLAB / SIMULINK is employed, and the results have been compared to the laboratory environment.

(Mondal & Yuvarajan, 2013) [4] In recent years, unconventional energy sources such as wind and solar have received increasing attention as a viable means of generating electricity. This paper will discuss a hybrid system that includes a wind turbine and a permanent magnet synchronous generator (PMSG) and photovoltaic panels integrated with a battery to store additional energy when available and to provide additional energy demand in the event of a shortage. The photovoltaic panel powers the battery through a SEPIC converter for the detection of the maximum power point (MPPT). The PMSG powers the battery through a boost converter which regulates the power. The outputs of the wind and photovoltaic arrays share a common intermediate circuit, through which the total power of the hybrid system is routed to a three-phase load using a space vector pulse width modulation (SV-PWM) inverter. The controller, modeled in MATLAB / Simulink software, is simple and implemented via real-time simulation using the dSPACE board.

(Abdel-Geliel et al., 2014) [5] This article is devoted to the study of the conversion of renewable energy resources into electrical energy in an autonomous hybrid power generation system. The hybrid system consists of a 230 kW wind turbine, a 30 kW microturbine and parallel dual-flow solar water heaters. Solar heaters are used to partially preheat the air entering the combustion chamber of the microturbine to reduce fuel consumption. The dynamic behavior and simulation results are analyzed to extract the maximum energy harvested from a variable speed wind power generation system. The hybrid model was simulated in different wind speed conditions. A supervisory controller is designed to manage between the peak power captured by the wind turbine and the power produced by the microturbine to meet load demands and wind energy fluctuations due to wind speed fluctuations. Based on 2013 data, solar heaters saved an average of \$ 15.4 per hour per month.

(Sikder & Pal, 2020) [6] This paper described a new method for autonomously hybrids distributed energy resources. The reliability of a power system relying on a personal renewable energy source is diminished due to the fluctuation of renewable energy sources. To resolve the difficulties, the memory system is incredibly huge, which raises the complete system cost by reducing adaptability significantly. An automated hybrids energy infrastructure that combines wind and solar power to produce power is being designed to remedy the problem. The hybrid system enhances electricity production while increasing storage capacity, ensuring that the customer is always supplied. The proposed system was modeled with Matlab / Simulink and verified in different sources and load conditions without affecting the power quality problem.

(Bajestan et al., 2019) [7] This paper proposes a new autonomous wind energy conversion system (SWECS) based on a variable speed permanent magnet synchronous generator (PMSG). The interface between the PMSG and the island load is made via a quasi Z source inverter (qZSI) with battery storage system. The battery-buffered qZSI can mitigate stochastic fluctuations in wind energy fed to the load and improve voltage and frequency regulation. In addition to battery storage, the proposed SWECS uses discharge charge to better maintain active power balance and DC link voltage

stability during over-generation conditions and sudden load changes. The proposed control system can provide uninterrupted and reliable power to sensitive loads in various SWECS power generation scenarios and sudden changes in load demand. In addition, the proposed controller offers maximum power point monitoring (MPPT), which is essential for the optimal operation of SWECS. The result of the MATLAB / SIMULINK simulations is used to verify the feasibility of the proposed technology.

(Pathak et al., 2015) [8] This article examines the use of permanent magnet synchronous generators (PMSGs) for a wind energy conversion system (WECS) and a self contained hybrid diesel engine generator system (DG ). battery-powered power generator. Filing system (BESS). For voltage regulation at the Point of Common Coupling (PCC) and symmetrical power supply via the DG set, a regulation algorithm based on single-phase DQ theory is applied for switching the voltage source converter (VSC) of the BESS and the maximum Power Point Sense (MPPT) is performed for WECS using an incremental conductance technique to switch a DC-DC boost converter. The simulated results of the generated model of the suggested autonomously hybrids program designed in MATLAB show that the controllers function well and that the hybrid consumption and energy fine chemical.

(Malla et al., 2018) [9] In the current scenario, electricity is important for daily activities, but unfortunately electricity is not available in many areas due to problems in the power grid. The best option for these rural areas is to establish a self-sufficient local energy system to provide people with the energy they need for a better livelihood. Most diesel generators are used to generate electricity, but they are not economical and environmentally friendly because the price of diesel increases day by day and emits carbon and noise products during operation. The alternative is a self-sufficient energy system based on renewable energy. Wind power generation is the most popular among renewable energy systems, and photovoltaic power systems are also gradually increasing in society. The integration of two or more renewable systems provides greater reliability than autonomous power systems. This paper proposes an autonomous hybrid wind and solar power generation system for rural applications. Also included are Maximum Power Point Tracker (MPPT) converters to obtain the maximum available power from renewable sources. For added reliability, a battery with a controller based on the appropriate voltage is also integrated into the system. Also, most of the distribution loads in a three-phase power system are unbalanced, so balanced load bus voltages must be maintained for good power quality. To maintain the good quality of the power supply, the control is designed so that the inverter maintains the single-phase voltages at the reference values. Many controllers are designed and tested in MATLAB Simulink under balanced and unbalanced load conditions. The performance of the controllers is quite satisfactory in a variety of possible conditions.

(Yu et al., 2019) [10] This paper proposes the design and multimodal operation of a new double stator toroidal winding permanent magnet vernier machine (DSTW-PMV) intended for the hybrid wind photovoltaic generation system (W - PV). . In the W-PV system, wind and photovoltaic energy complement each other to reduce power fluctuations. Multimode operation can stabilize the machine output voltage with high continuity at different speeds to solve the inherent problem of indeterminate wind speed and further improve the smooth performance of the whole W-PV system. First, the optimization of the machine is performed to obtain the optimal combination of pole pairs and geometric topology for the proposed machine. Secondly, based on the optimal topology, the multimode operating principle of output voltage matching is illustrated. Taking advantage of the variety of toroidal winding configurations and terminal connection strategies, the proposed machine offers 54 operating modes with different output voltages at rated speed. As a result, the machine speed can be expanded to three rated speeds under the rated output voltage with high continuity. Additionally, some modes generate the rated output voltage at the same rate, contributing to high redundancy and high operational efficiency. Therefore, with multimodal operation and photovoltaic backup, the entire power generation system offers greater flexibility, stability, reliability and efficiency

Author Name and year	Work done	Conclusion
Sikder & Pal, 2020[6]	Different approach for autonomous hybrid distributed generation	Hybrid system increases the generation capacity without expanding the storage unit
Radwan & Mohamed, 2020) [20]	A complete wind turbine, based on a PMSG, is connected to the power grid via connected (VSCs)	The results of the nonlinear simulation are presented in the time domain under different operating conditions to validate the effectiveness of the proposed topology.
El-Raouf et al., 2019 [1]	MPPT was implemented to PV, wind, and fuel cells independently via three DC-DC buck - boost converter using the Cuckoo search (CS) AI technique	the Cuckoo Search regulate technology's capabilities to attain MPPT for every generating station
Bajestan et al., 2019) [7]	Proposed SWECS with PMSG	Provide uninterrupted and reliable power also offer MPPT
Malla et al., 2018 [9]	the controller is designed so that the inverter maintains the single-phase voltages at the reference values	The performance of the controllers is quite satisfactory in a variety of possible conditions.

### III. Methodology Used

The large-scale wind/solar hybrid system is connected to grid via a booster station. The system consists of wind power system and photovoltaic system. In order to improve the transient voltage stability of the large-scale wind/solar hybrid system, reactive power compensation device STATCOM is connected to grid. The compensator is being proposed for further enhancement in the output parameters like THD in voltage, THD in current and active power output.

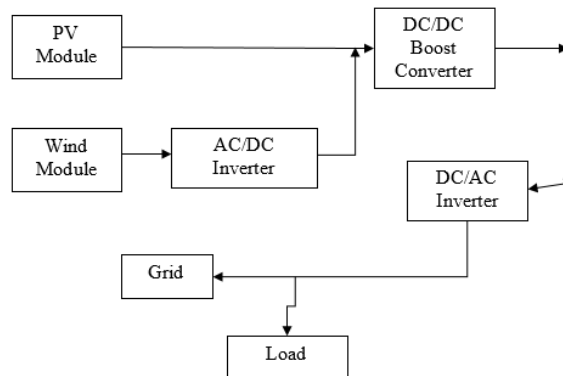

Figure 2: Hybrid Energy System

#### CHSA algorithm

Conventional search methods have long been applied to solve engineering design problems. Although these methods find promising results in many real problems, they may fail in more complex design problems. In real design problems, the number of decision variables can be very large and their effect on the objective function can be very complicated. The objective function may have many local optima, whereas the designer is interested in the global optimum. Such problems cannot be handled by conventional methods that only find local optima. In these cases, efficient optimization methods are needed.

Hawks (Hawk family or corvids) are considered the most intelligent birds. They contain the largest brain relative to their body size. Based on a brain-to-body ratio, their brain is slightly lower than a human brain. Evidences of the cleverness of Hawks are plentiful. They have demonstrated self-awareness in mirror tests and have tool-making ability. Hawks can remember faces and warn each other when an unfriendly one approaches. Moreover, they can use tools, communicate in sophisticated ways and recall their food's hiding place up to several months later.

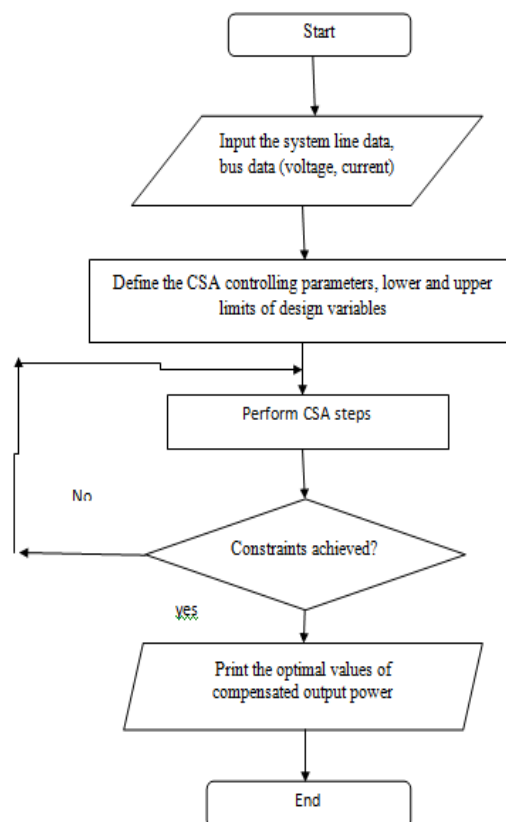

Figure 3: Designing of proposed methodology

### IV. Result And Discussion

In a world where energy resources are diminishing, the usage of renewable energy sources is critical to meeting rising needs. The best option for combating the use of finite resources is to generate electricity using solar and wind energy resources. The best feature is that it really is a non-polluting source of energy. Our research on these assets will now be carried out in the field.

The project focuses on using MATLAB/SIMULINK software to analyze a hybrid solar/wind energy system. The system is designed to work in conjunction with the grid system in order to maximize efficiency.

Case 1: Hybrid wind energy system with STATCOM

PV arrays with 10 cells within every series and 40 parallel branches have been used to model the solar panel, which together produce the DC output from the system. Variable illumination of 1000 lux is available, as well as a temperature range of 250 C. This output is then merged with the DC output from the wind energy system and further sent to the inverter for its AC conversion. The DC output waveform have been illustrated in the fig. below

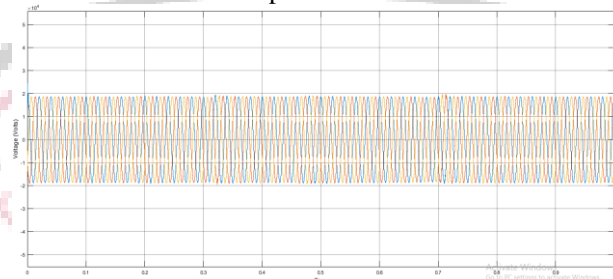

Figure 4: Voltage output from the system with STATCOM at bus B2 (loads)

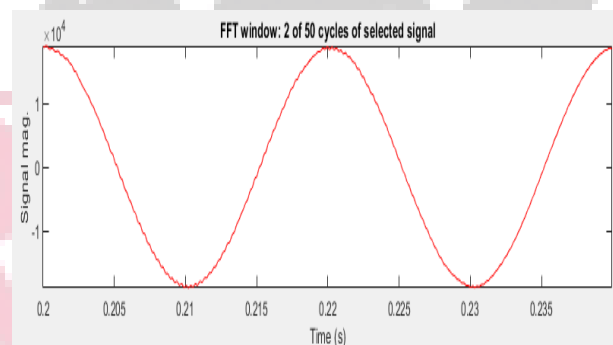

Figure 5: FFT window of Voltage output from the inverter in system having STATCOM

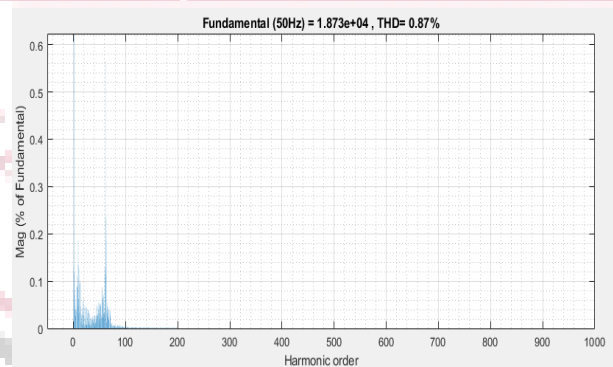

Figure 6: THD % Voltage output from the inverter in system having STATCOM

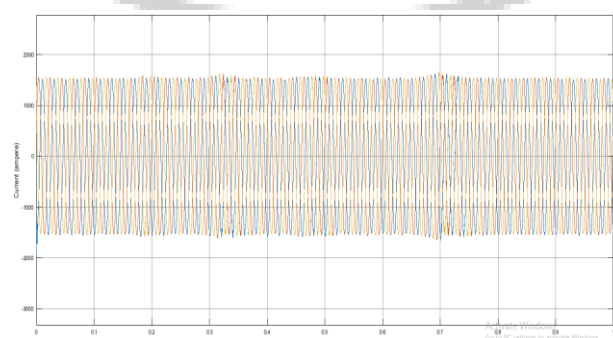
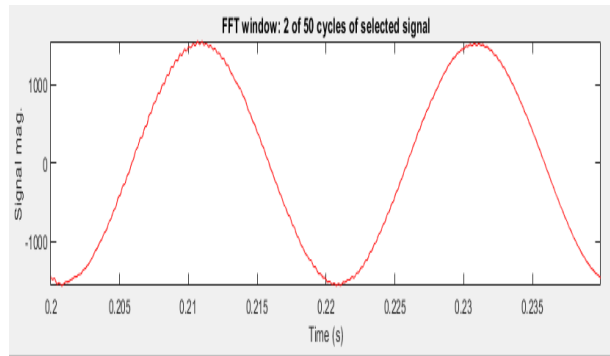
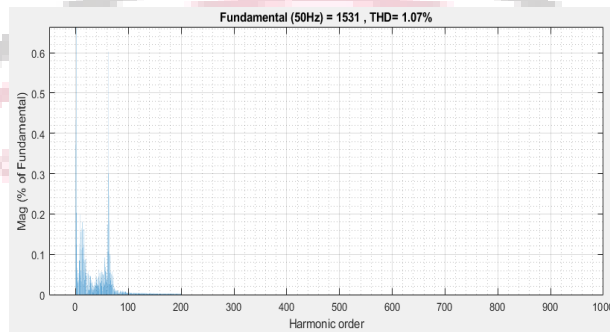

Figure 7: Current output from the system with STATCOM B2 (loads)



**Figure 8: FFT window of Current output from the system with STATCOM**



**Figure 9: THD% of Current output from the system with STATCOM**

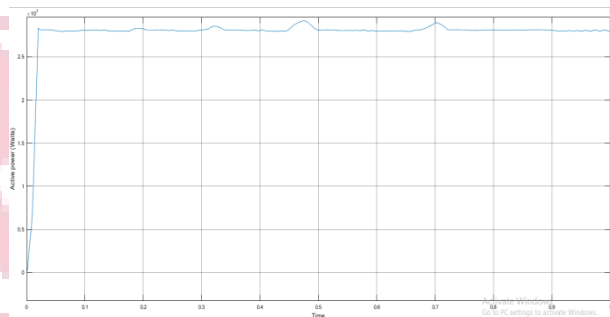

**Figure 10: Active power output from the system with STATCOM B2 (loads)**

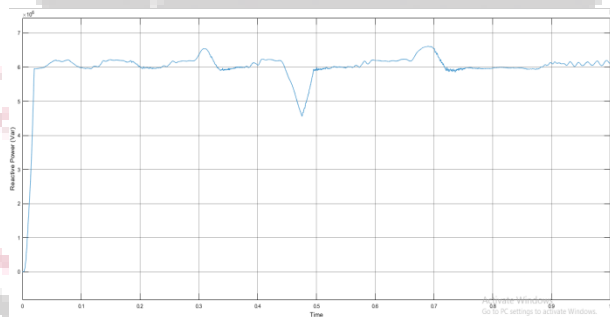

**Figure 11: Reactive power output from the system with STATCOM B2 (loads)**

Case 2: Hybrid wind energy system with constrained Hawk search algorithm regulated compensator

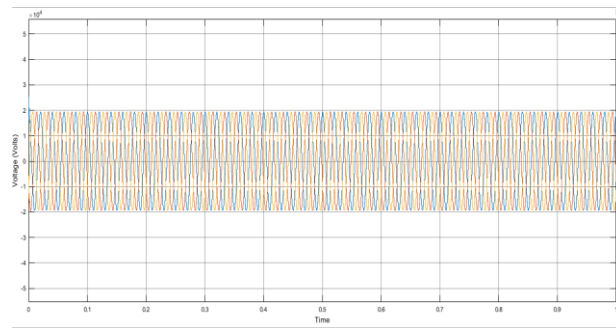

Figure 12: Voltage output from the system with constrained Hawk search algorithm regulated compensator

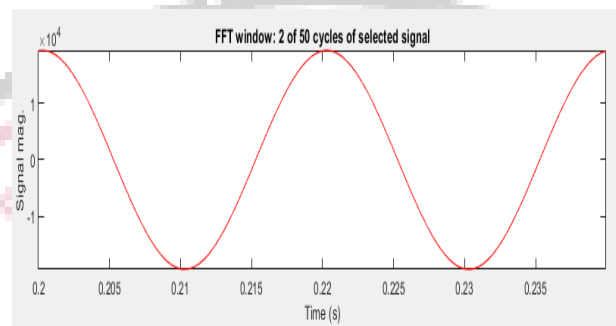

Figure 13: FFT window of Voltage output from the system with CHSA regulated compensator

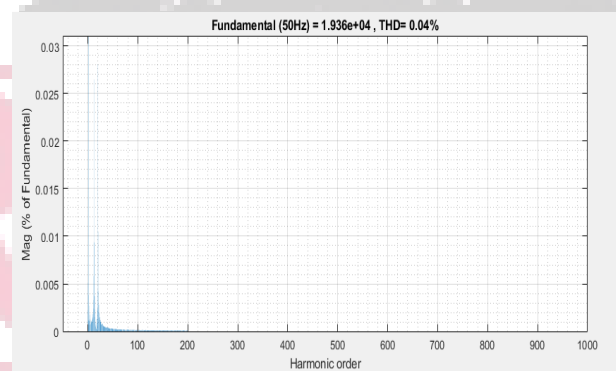

Figure 14: THD% of Voltage output from the system with CHSA regulated compensator

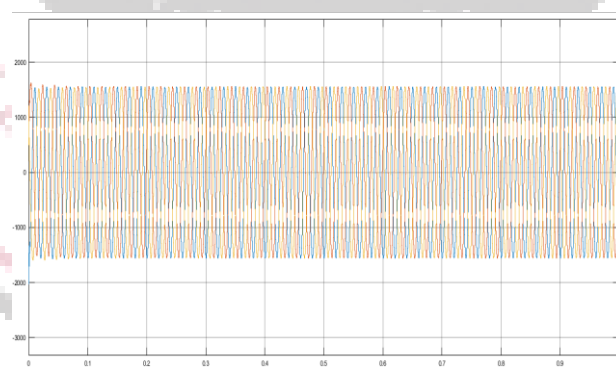

Figure 15: Current output from the system with constrained Hawk search algorithm regulated compensator

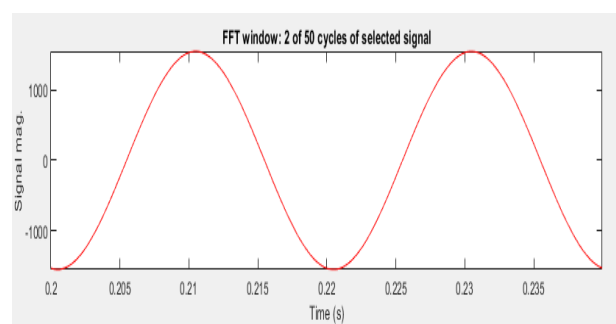

Figure 16: FFT window of Current output from the system with CHSA regulated compensator

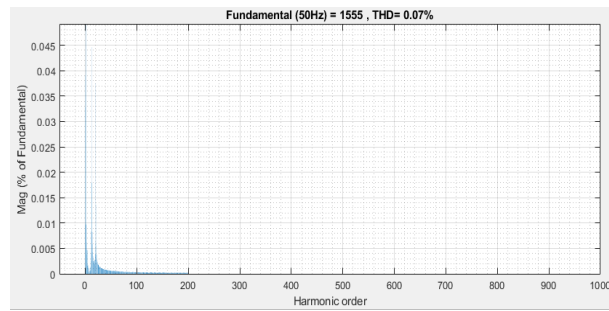

Figure 17: 7THD% of Current output from the system with CHSA regulated compensator

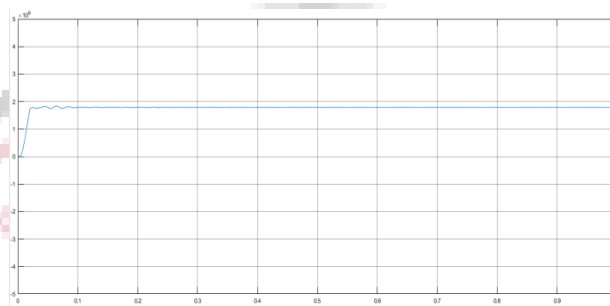

Figure 18: Reactive power output from the system with constrained Hawk search algorithm regulated compensator

## V. Conclusion

The demand for electricity is increasing day by day, which cannot be fulfilled by non-renewable energy sources alone. Renewable energy sources such as solar and wind are omnipresent and environmental friendly. The renewable energy sources are emerging options to fulfill the energy demand, but unreliable due to the stochastic nature of their occurrence. Hybrid renewable energy system (HRES) combines two or more renewable energy sources like wind turbine and solar system.

The work here presents a hybrid renewable energy system in MATLAB/SIMULINK environment for analysis. We have designed a controller for the compensator based on the optimizing algorithm which is a part of artificial intelligence. Following main conclusions were drawn:

The active power output from the system has enhanced to 30MW in the system having compensator regulated from the proposed controller that is constrained Hawk search algorithm from 28MW which is also stable as compared to the system having STATCOM.

The Hawk search algorithm is so constrained in a manner such that the output voltage and current distortion has also reduced. The voltage output distortion level from the hybrid solar wind energy system was found to be 0.04% which is less than 0.87 % of the system having basic STATCOM.

The Hawk search algorithm has collectively proved to be effective reducing the distortion level of current output also. The current distortion level has also come down to 0.07% using the proposed controller from the 1.07% in the solar wind hybrid system with basic STATCOM.

The system is also integrated with the grid energy system. The line voltage being maintained to 20 KVolts. The reactive power output has also reduced. The algorithm has proven to be more effective in the compensating the reactive power as well.

## References

- A., Al-Ahmar, M. A., & Bendary, F. M. E. (2019). MPPT of PV-Wind-Fuel Cell of Off-Grid Hybrid System for a New Community. 2018 20th International Middle East Power Systems Conference, MEPCON 2018 - Proceedings, 480–487. <https://doi.org/10.1109/MEPCON.2018.8635165>
- [2] Ghosh, K., Guha, A., Duttagupta, S. P., & Gupta, P. K. (2016). A solar PV integrated contoured kite as a hybrid power generating system. India International Conference on Power Electronics, IICPE, 2016-November. <https://doi.org/10.1109/IICPE.2016.8079511>
- [3] Bharanikumar, R., Yazhini, A. C., & Kumar, A. N. (2008). Novel maximum power point tracking controller for wind turbine driven permanent magnet generator. 2008 Joint International Conference on Power System Technology POWERCON and IEEE Power India Conference, POWERCON 2008. <https://doi.org/10.1109/ICPST.2008.4745264>
- [4] Mondal, A., & Yuvarajan, S. (2013). A dSPACE-based control of a hybrid renewable energy system with wind and photovoltaic power. 2013 4th IEEE International Symposium on Power Electronics for Distributed Generation Systems, PEDG 2013 - Conference Proceedings. <https://doi.org/10.1109/PEDG.2013.6785648>



- [5] Abdel-Geliel, M., Zidane, I. F., Anany, M., & Rezeka, S. F. (2014). Modeling and simulation of a hybrid power generation system of wind turbine, micro-turbine and solar heater cells. *IEEE International Conference on Control and Automation, ICCA*, 1304–1309. <https://doi.org/10.1109/ICCA.2014.6871112>
- [6] Sikder, P. S., & Pal, N. (2020). Modeling of an intelligent battery controller for standalone solar-wind hybrid distributed generation system. *Journal of King Saud University - Engineering Sciences*, 32(6), 368–377. <https://doi.org/10.1016/j.jksues.2019.02.002>
- [7] Bajestan, M. M., Madadi, H., & Shamsinejad, M. A. (2019). Control of a new stand-alone wind turbine-based variable speed permanent magnet synchronous generator using quasi-Z-source inverter. *Electric Power Systems Research*, 177(August), 106010. <https://doi.org/10.1016/j.epr.2019.106010>
- [8] Pathak, G., Singh, B., & Panigrahi, B. K. (2015). Permanent magnet synchronous generator based wind energy and DG hybrid system. 2014 18th National Power Systems Conference, NPSC 2014. <https://doi.org/10.1109/NPSC.2014.7103862>
- [9] Malla, S. G., Dadi, P. K., & Dadi, J. (2018). Wind and photovoltaic based hybrid stand-alone power generation system. 2017 International Conference on Energy, Communication, Data Analytics and Soft Computing, ICECDS 2017, 3718–3725. <https://doi.org/10.1109/ICECDS.2017.8390158>
- [10] Yu, J., Liu, C., & Zhao, H. (2019). Design and Multi-Mode Operation of Double-Stator Toroidal-Winding PM Vernier Machine for Wind-Photovoltaic Hybrid Generation System. *IEEE Transactions on Magnetics*, 55(7), 1–7. <https://doi.org/10.1109/TMAG.2019.2906849>
- [11] Ahmad, S., Uddin, M. J., Nisu, I. H., Ahsan, M. M. U., Rahman, I., & Samrat, N. H. (2017). Modeling of grid connected battery storage wave energy and PV hybrid renewable power generation. *ECCE 2017 - International Conference on Electrical, Computer and Communication Engineering*, 375–380. <https://doi.org/10.1109/ECACE.2017.7912933>
- [12] Masoum, M. A. S., Mousavi Badejani, S. M., & Kalantar, M. (2010). Optimal placement of hybrid PV-wind systems using genetic algorithm. *Innovative Smart Grid Technologies Conference, ISGT 2010*, 1, 0–4. <https://doi.org/10.1109/ISGT.2010.5434746>
- [13] Fathabadi, H. (2017). Novel standalone hybrid solar/wind/fuel cell/battery power generation system. *Energy*, 140, 454–465. <https://doi.org/10.1016/j.energy.2017.08.098>
- [14] Kabalci, E. (2013). Design and analysis of a hybrid renewable energy plant with solar and wind power. *Energy Conversion and Management*, 72, 51–59. <https://doi.org/10.1016/j.enconman.2012.08.027>
- [15] Shen, D., Izadian, A., & Liao, P. (2014). A hybrid wind-solar-storage energy generation system configuration and control. 2014 IEEE Energy Conversion Congress and Exposition, ECCE 2014, 436–442. <https://doi.org/10.1109/ECCE.2014.6953426>
- [16] Jiang, P., Zhang, H., Xu, L., Li, X., Zhao, P., & Zhang, S. (2012). Research on a novel hybrid power system. 2012 IEEE International Conference on Mechatronics and Automation, ICMA 2012, 2494–2498. <https://doi.org/10.1109/ICMA.2012.6285738>
- [17] Hosseini, S. H., Haghghian, S. K., Danyali, S., & Aghazadeh, H. (2012). Multi-input dc boost converter supplied by a hybrid PV/Wind turbine power systems for street lighting application connected to the grid. *Proceedings of the Universities Power Engineering Conference*. <https://doi.org/10.1109/UPEC.2012.6398632>
- [18] Fathabadi, H. (2016). Novel highly accurate universal maximum power point tracker for maximum power extraction from hybrid fuel cell/photovoltaic/wind power generation systems. *Energy*, 116, 402–416. <https://doi.org/10.1016/j.energy.2016.09.095>
- [19] Kumar, P., & Palwalia, D. K. (2015). Decentralized Autonomous Hybrid Renewable Power Generation. *Journal of Renewable Energy*, 2015, 1–18. <https://doi.org/10.1155/2015/856075>
- [20] Radwan, A. A. A., & Mohamed, Y. A. R. I. (2020). Grid-Connected Wind-Solar Cogeneration Using Back-to-Back Voltage-Source Converters. *IEEE Transactions on Sustainable Energy*, 11(1), 315–325. <https://doi.org/10.1109/TSTE.2019.2890828>